

INTERLOCKER MULLION ASSEMBLY

INTERLOCKER MULLION ASSEMBLY

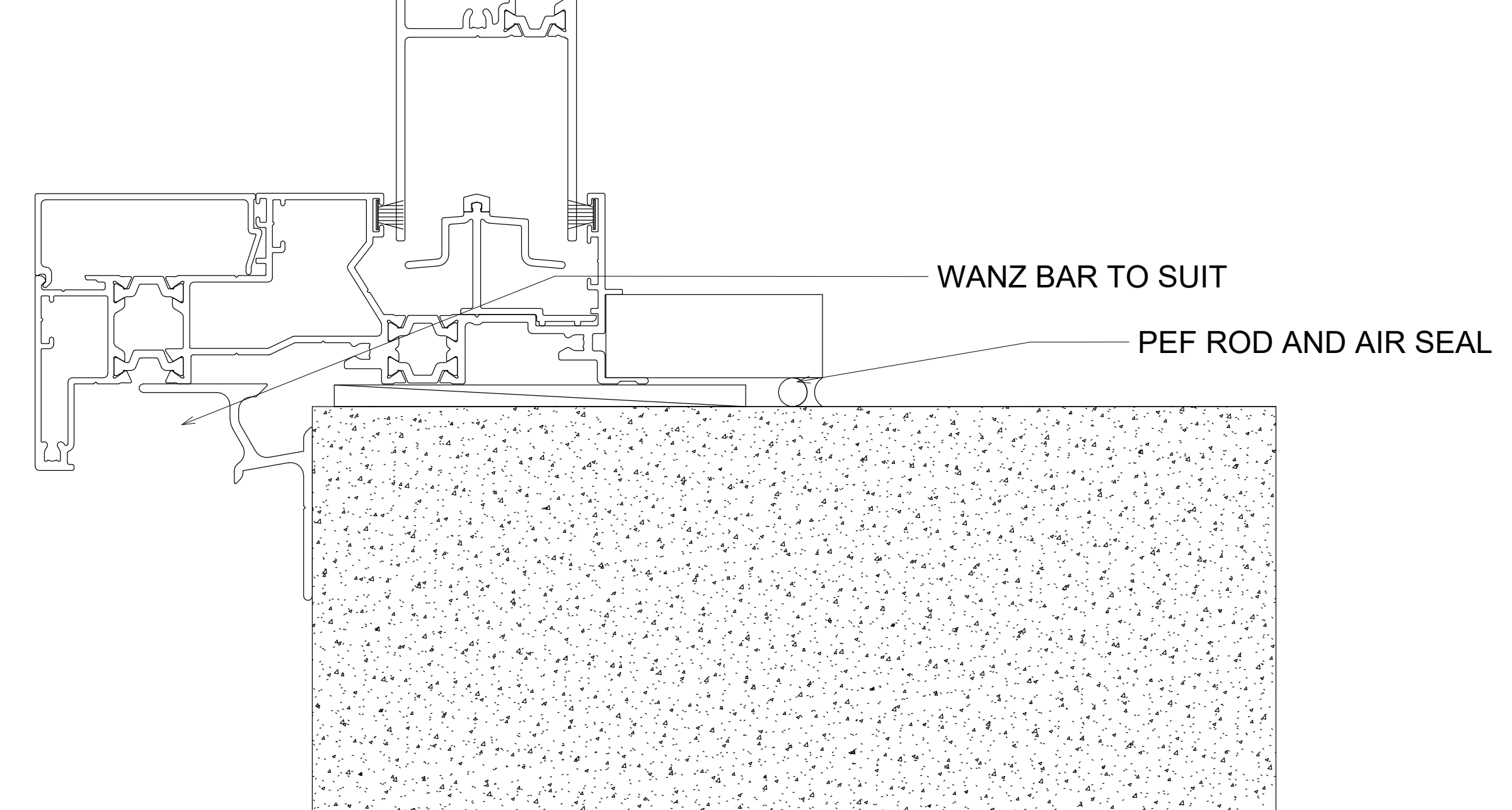

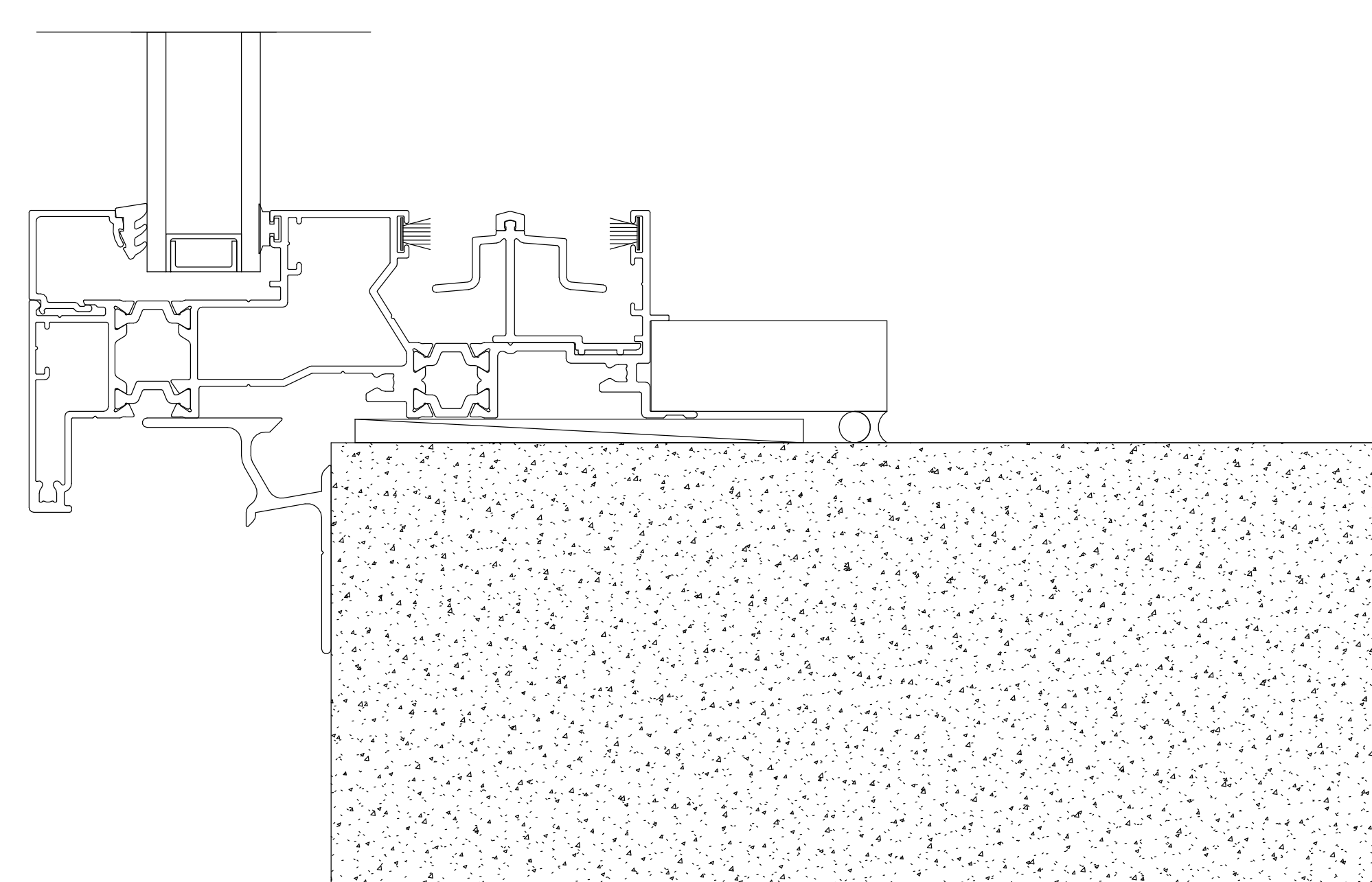

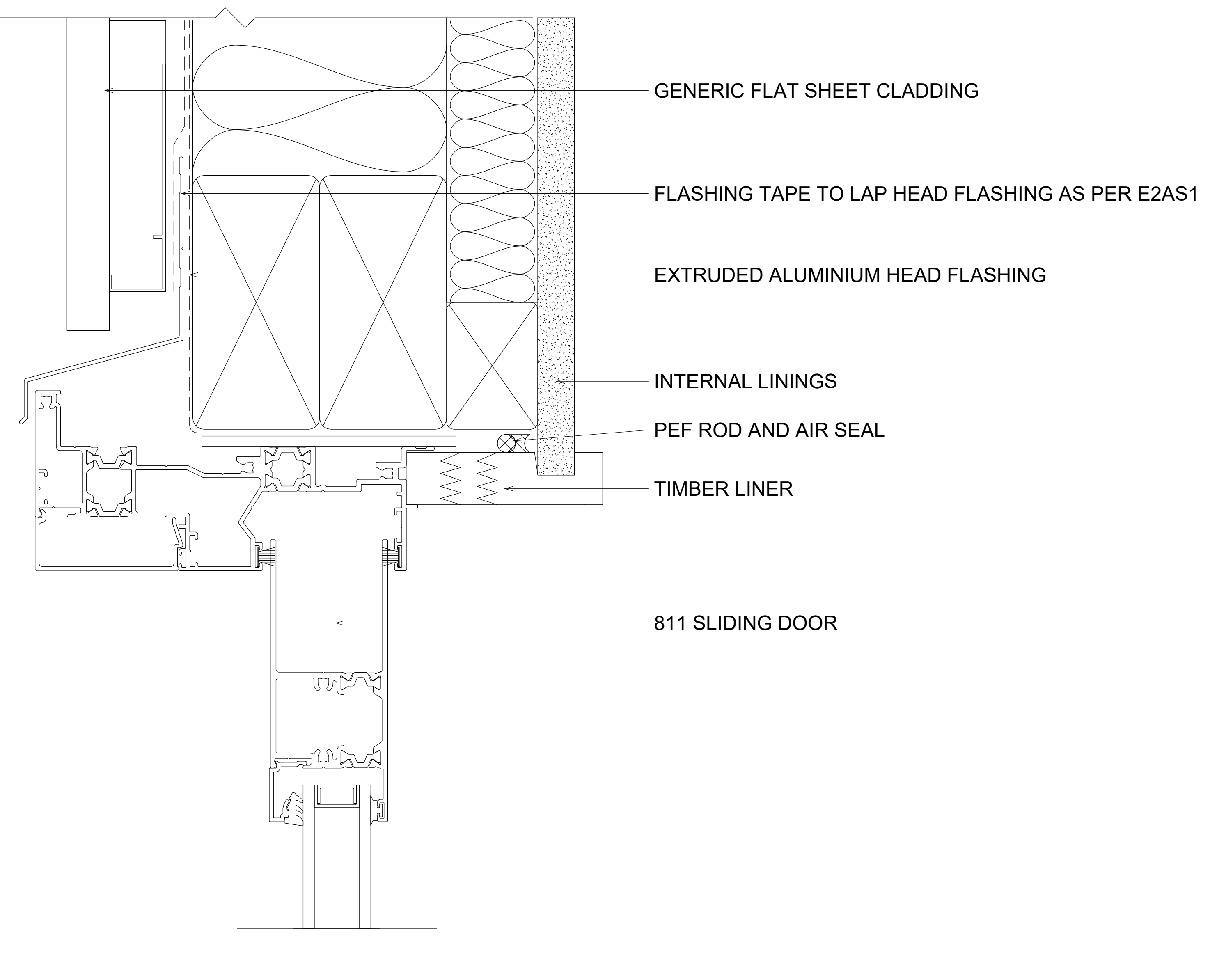
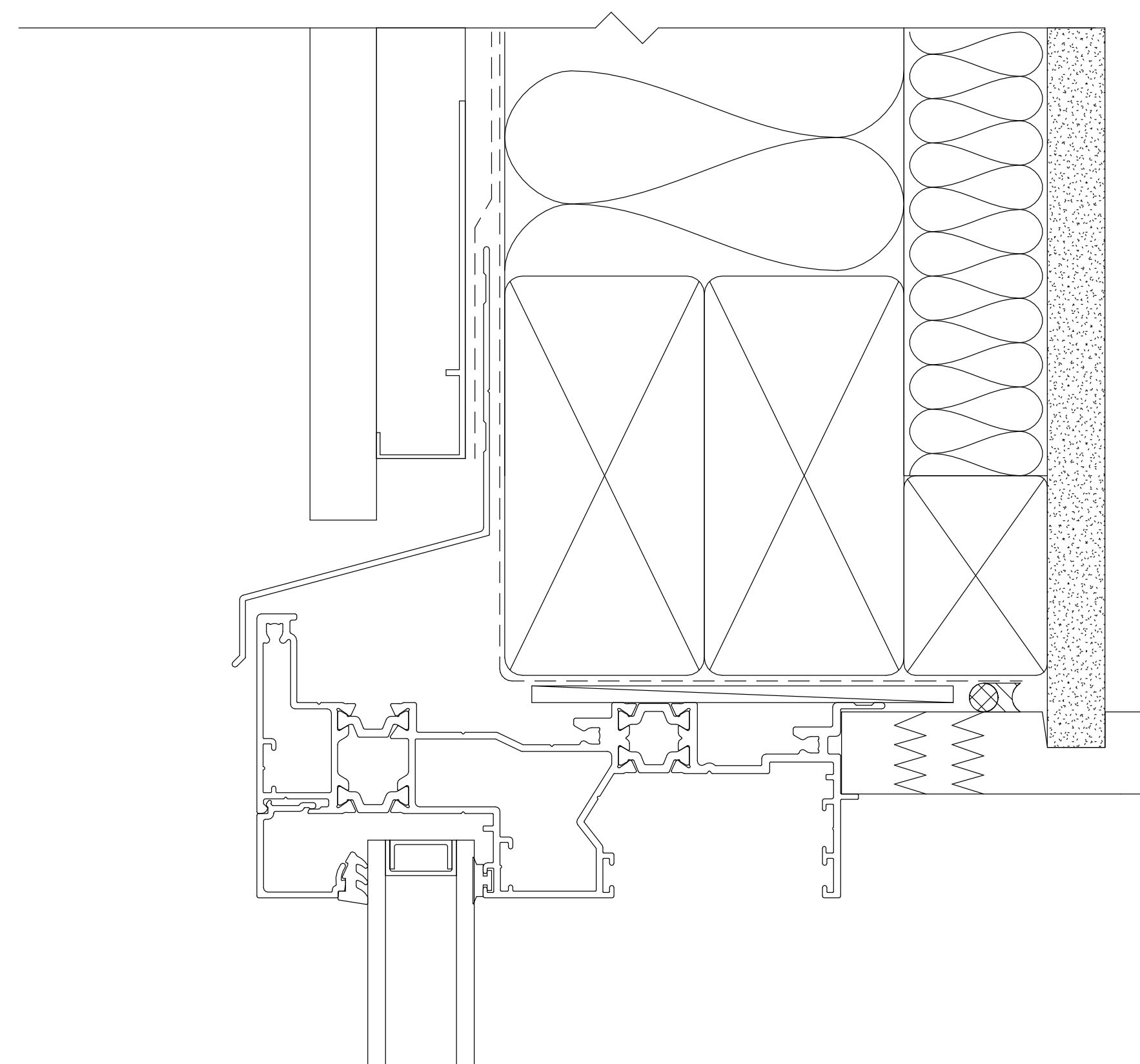
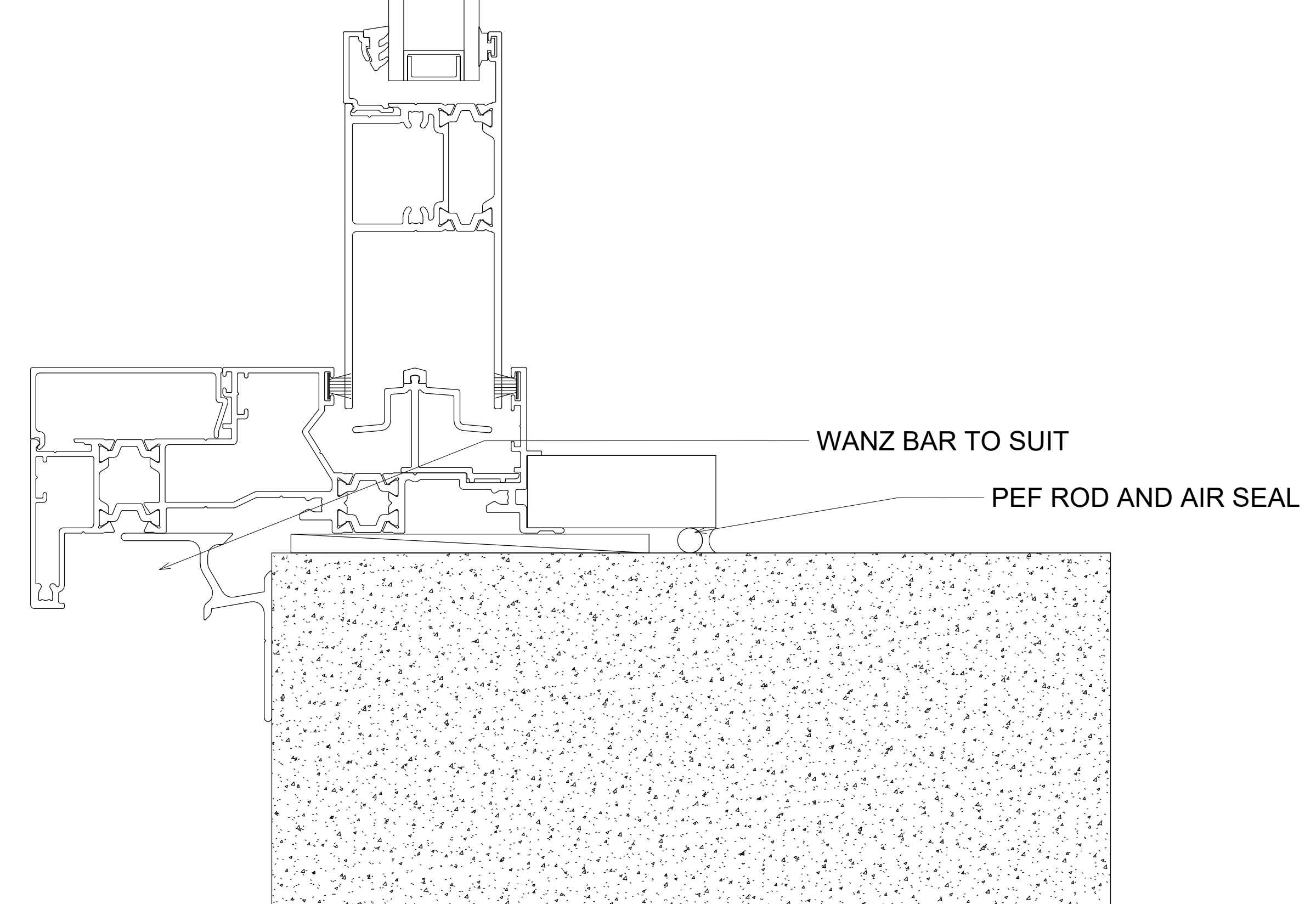
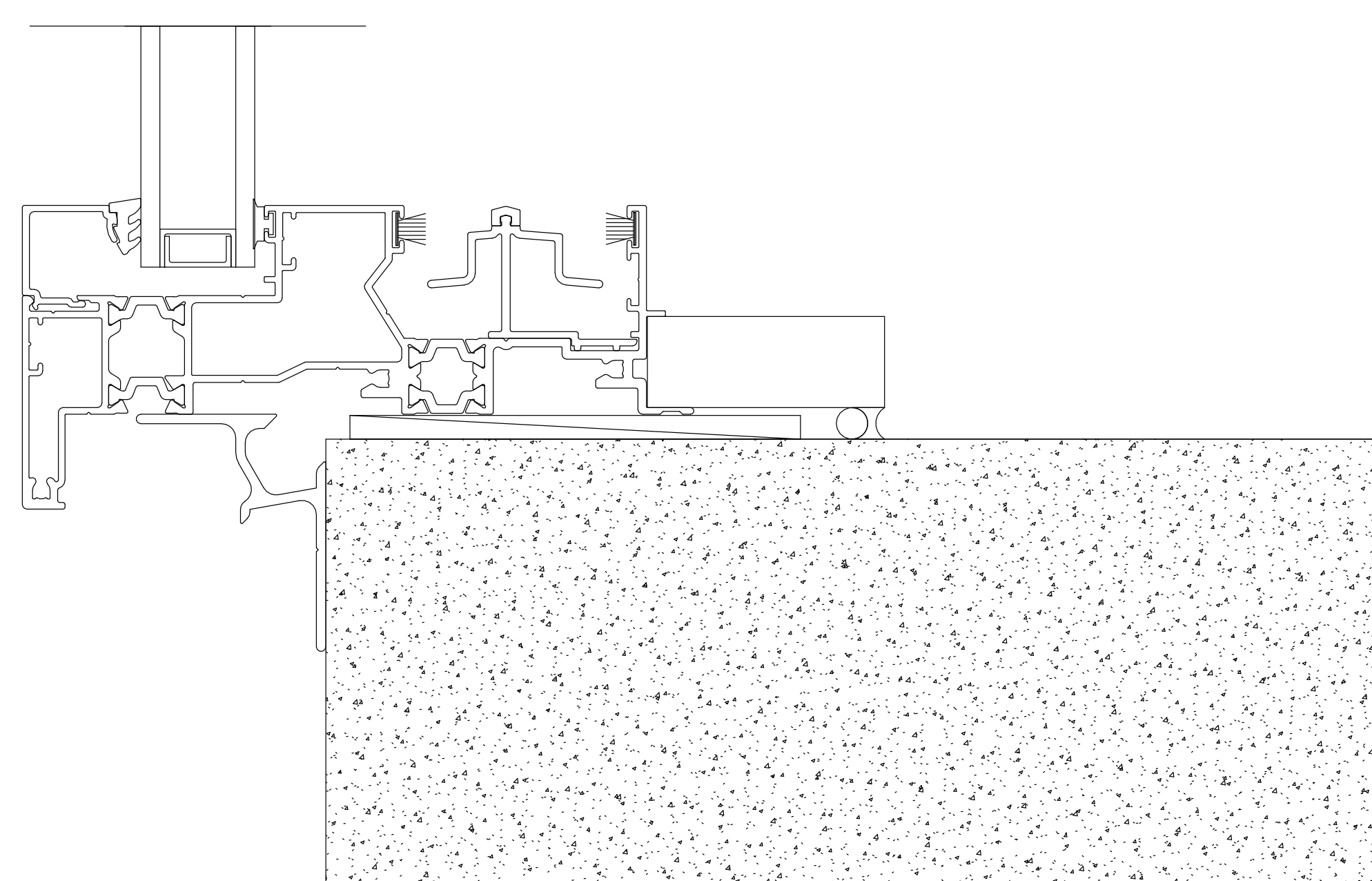
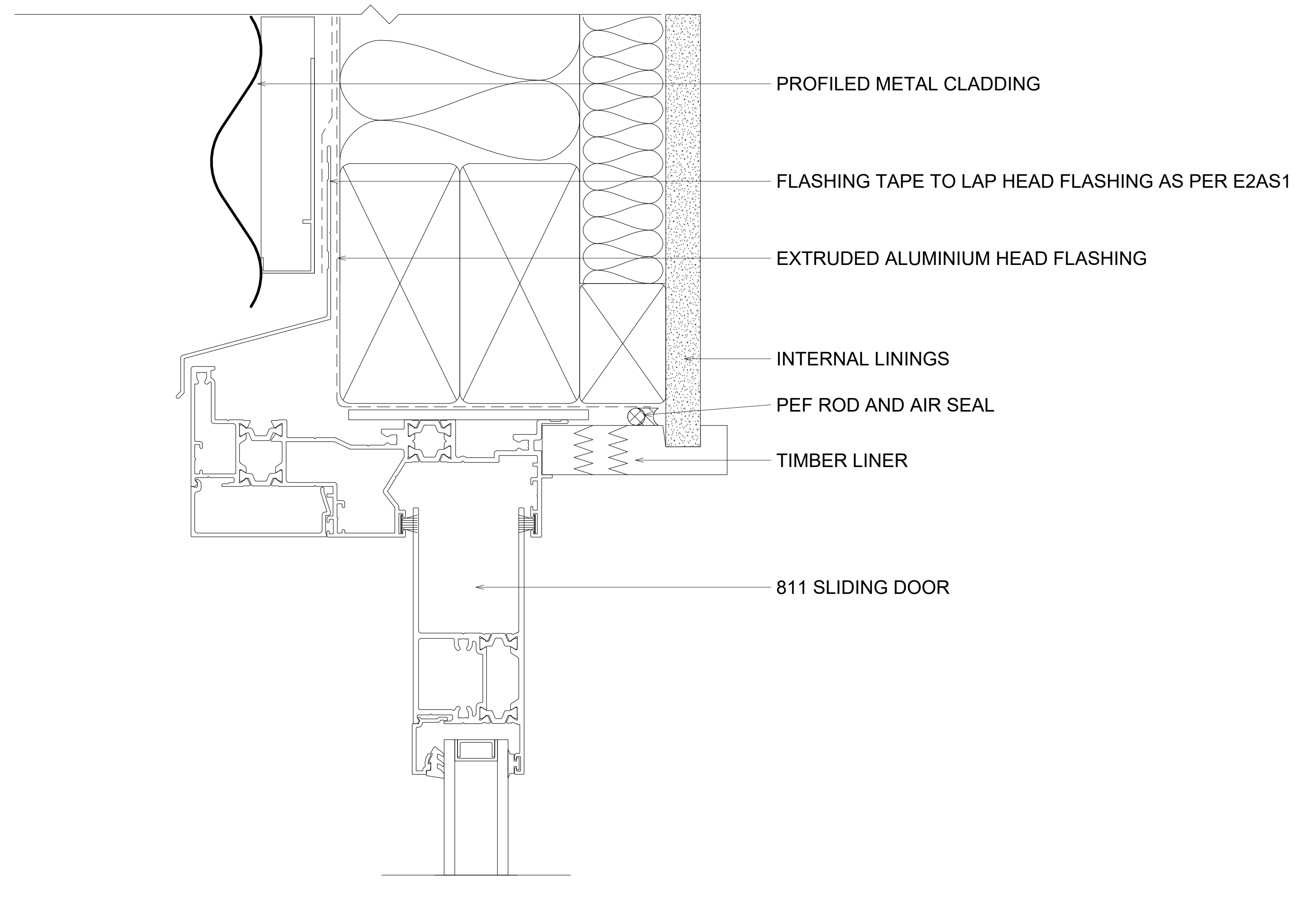
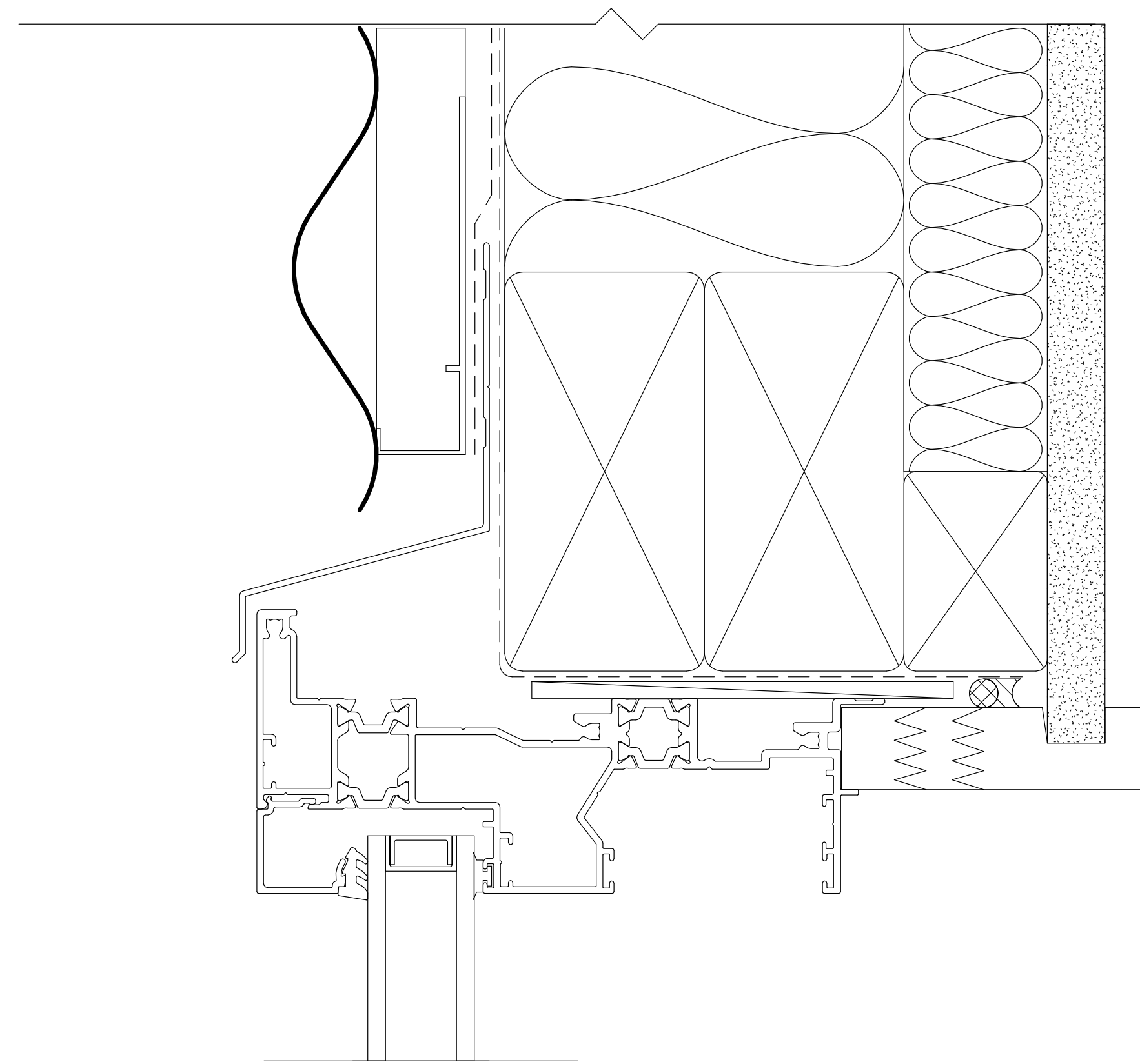
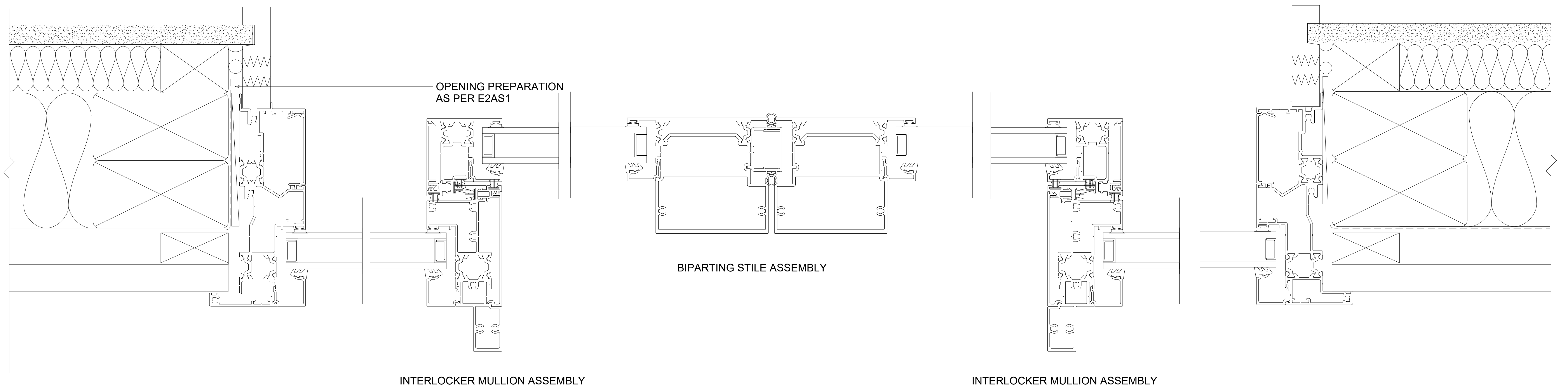
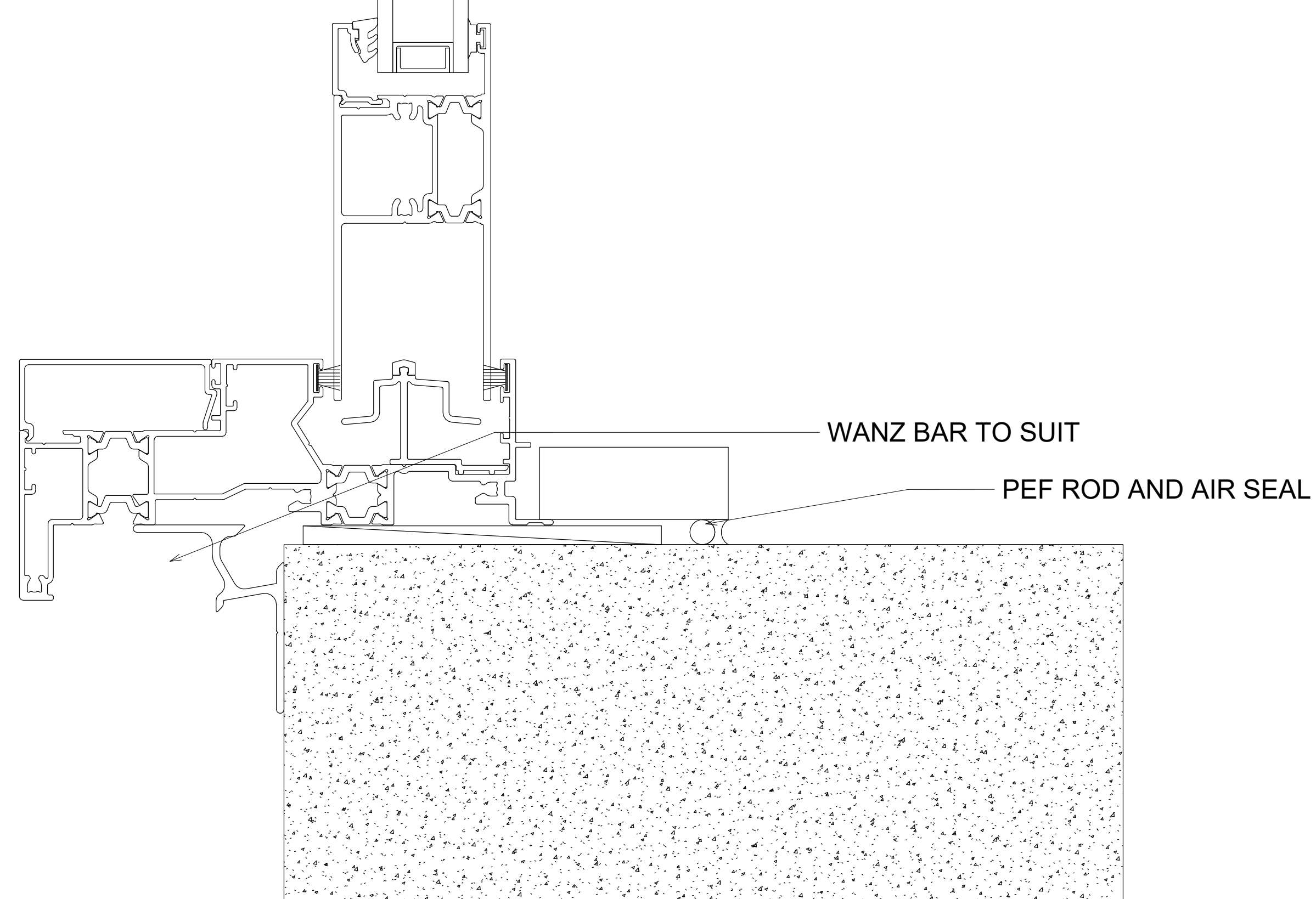
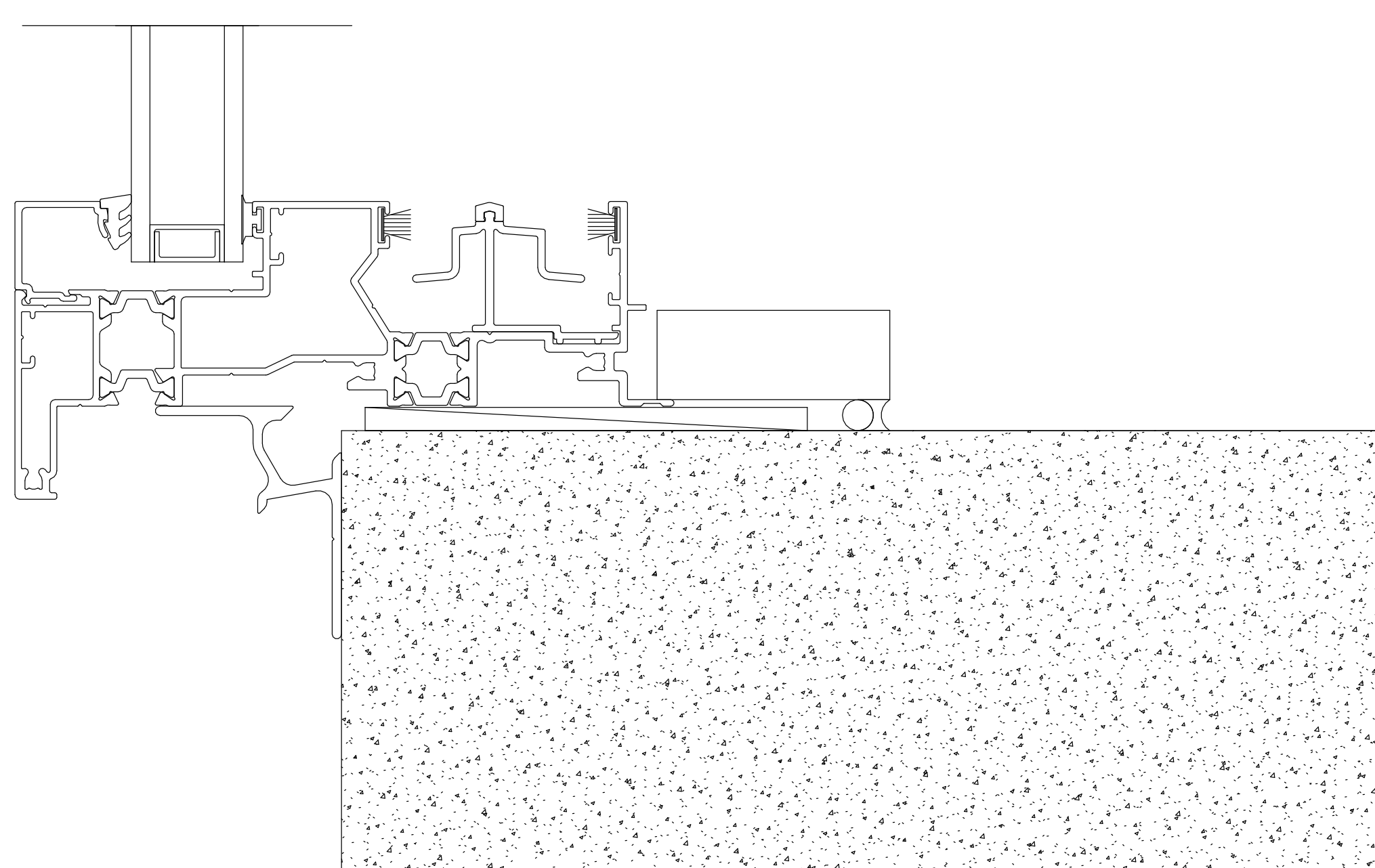
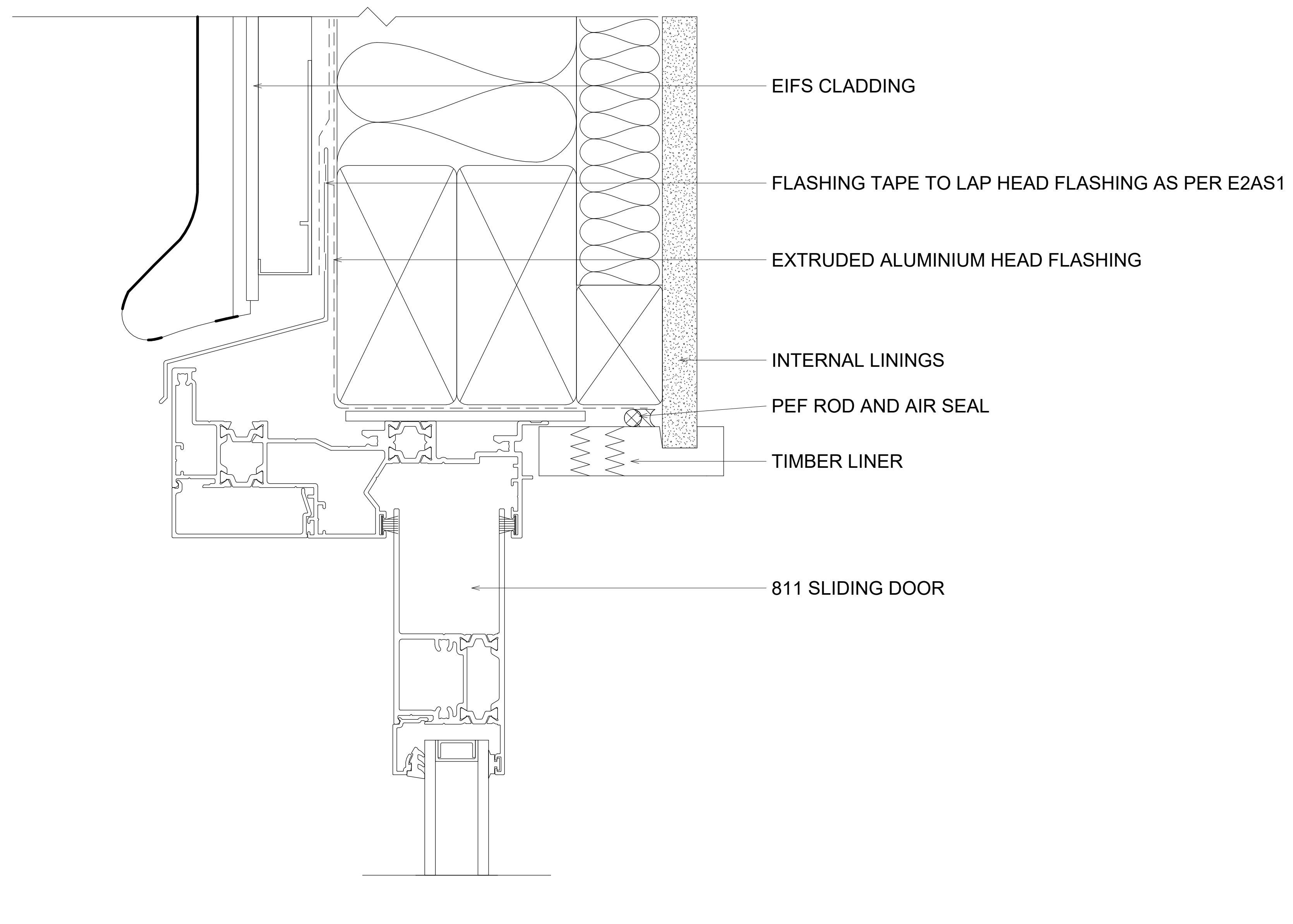
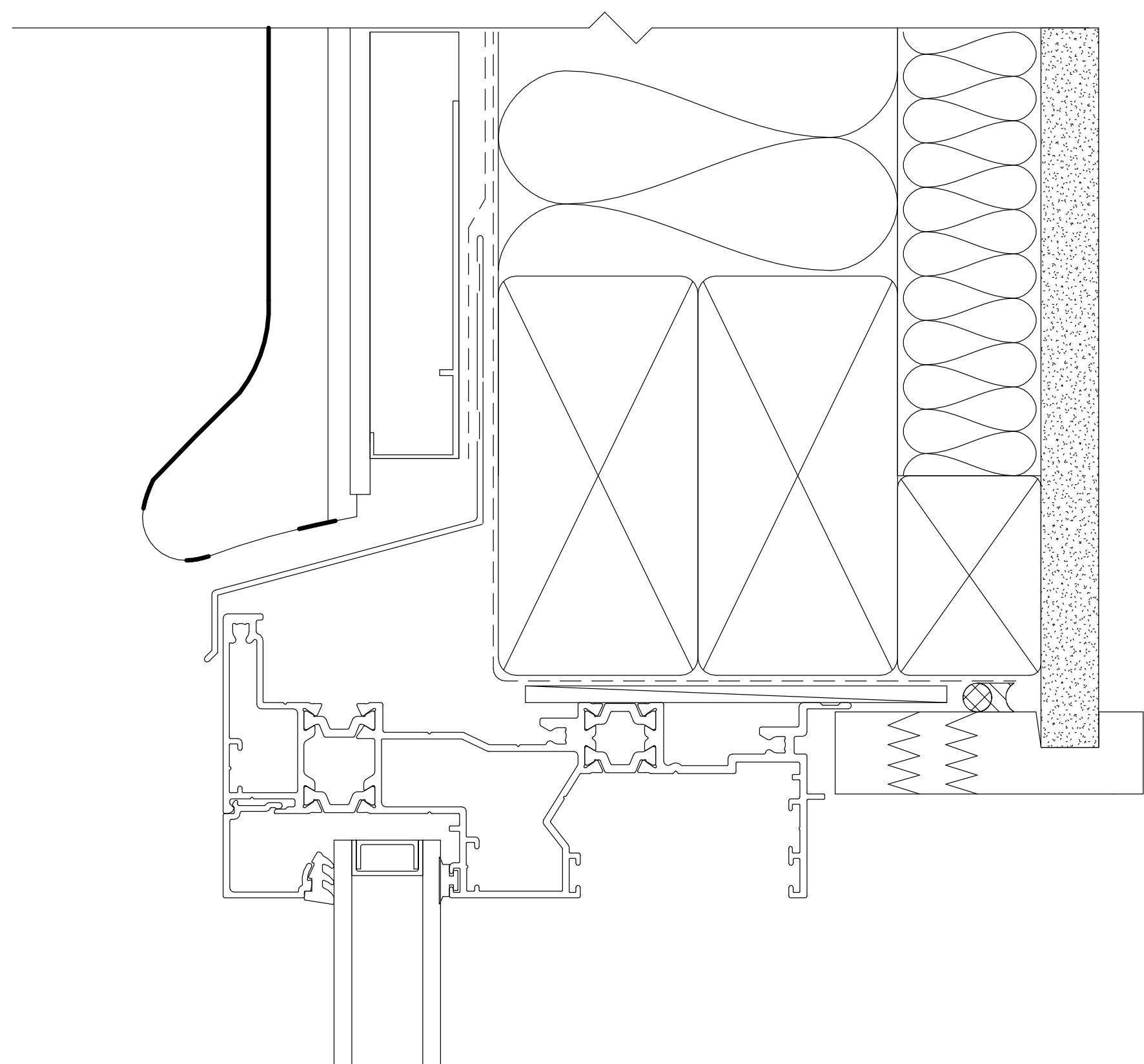
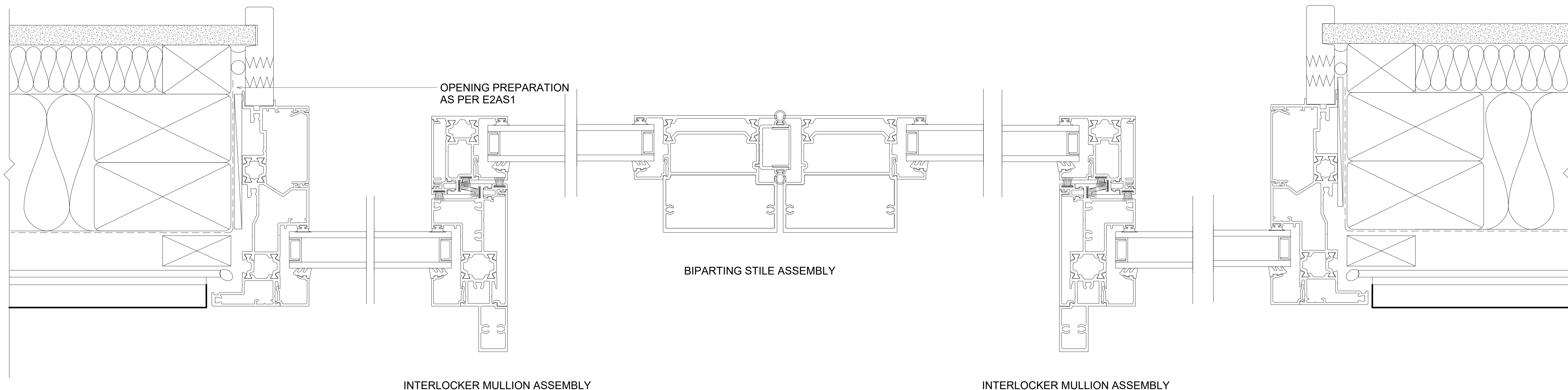



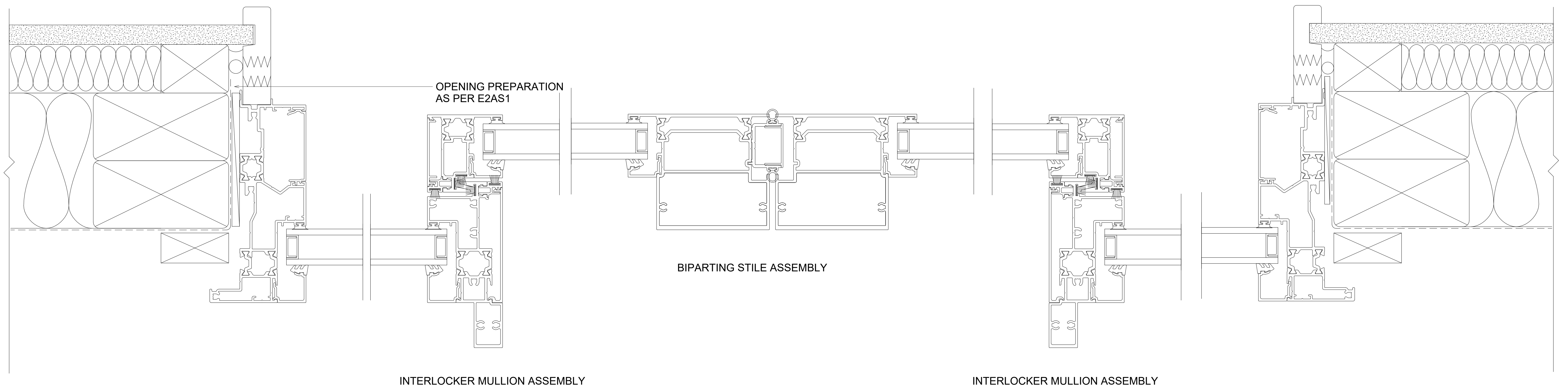

INTERLOCKER MULLION ASSEMBLY

INTERLOCKER MULLION ASSEMBLY

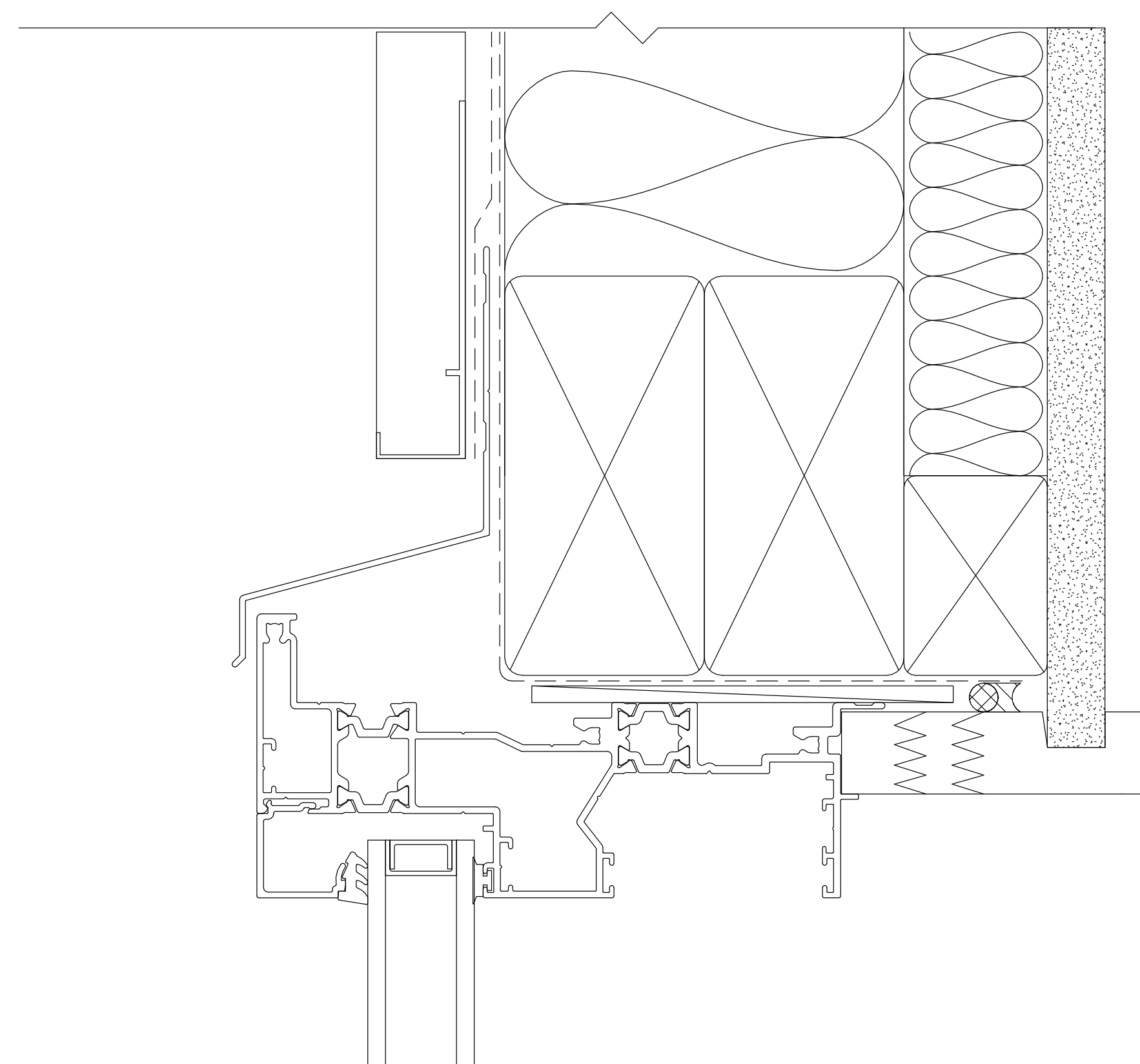

FLASHING TAPE TO LAP HEAD FLASHING AS PER E2AS1

EXTRUDED ALUMINIUM HEAD FLASHING

INTERNAL LININGS

PEF ROD AND AIR SEAL

TIMBER LINER

811 SLIDING DOOR

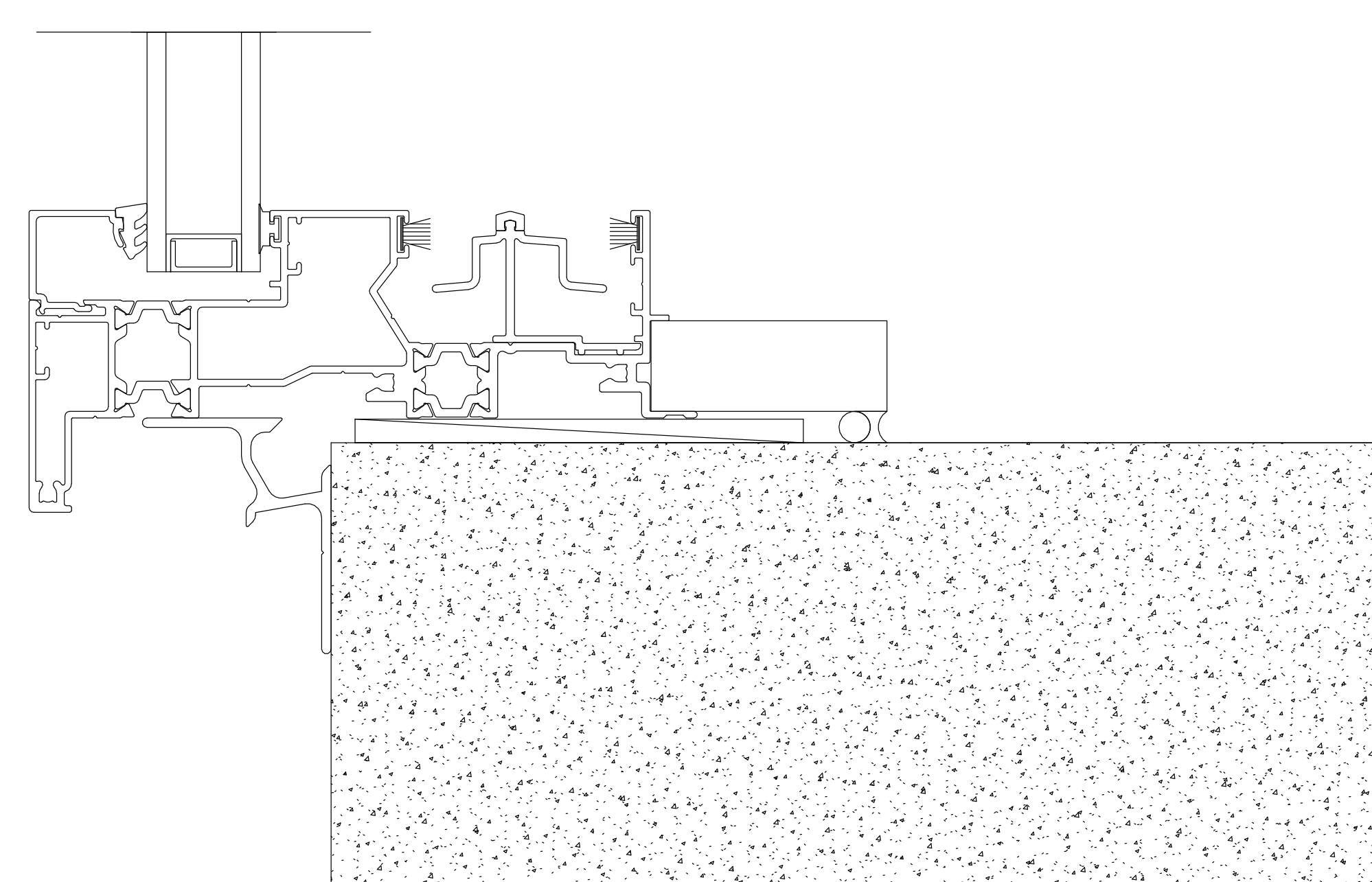

WANZ BAR TO SUIT

PEF ROD AND AIR SEAL